



INCLUSIVE. DURABLE. RELIABLE.



SIGNXPRESS INDIA

 www.signxpressindia.com

 info@signxpressindia.com

 RZ-8, Uttam Nagar East
New Delhi-110059 (INDIA)



Tactile

- PU Tactile
- SS Tactile
- ABS Tactile



Braille Sign

- Acrylic Braille Sign
- SS Braille Sign
- Aluminium Braille Sign
- Wooden Braille Sign
- Railing Braille Sign



Grab Bar

- Straight Grab Bar
- Swing Grab Bar
- Urinal Grab Bar
- U Shaped Grab Bar
- L Shaped Grab Bar

ABOUT US

Signxpress India is a leading manufacturer and exporter of innovative accessible and road safety products. With a commitment to inclusivity, quality, and modern design, we specialize in tactile tiles, Braille signage, grab bars, and other accessibility solutions. Our products are trusted by government agencies, public infrastructure projects, and institutions across India and abroad. With a global delivery network, we ensure safe, timely, and efficient door-to-door shipping of our solutions worldwide.

OUR VISION

To be a global leader in accessibility and road safety by empowering inclusive infrastructure and enhancing mobility for all individuals—regardless of ability.

OUR MISSION

- To innovate, manufacture, and supply world-class accessible and safety products.
- To promote inclusivity through reliable, user-friendly solutions that meet international standards.
- To ensure global reach with worldwide shipping and on-time delivery, enabling accessibility beyond borders.

Signxpress India – Innovating for Inclusion, Delivering Worldwide.



Signxpress India offers a premium collection of tactile products, including PU Tactile Tiles, Warning Strips, Directional Indicators, SS Tactile Indicators. Designed for global accessibility standards, our tactile solutions enhance safety and navigation for the visually impaired. We provide worldwide shipping, ensuring inclusive infrastructure solutions reach every corner of the globe.

PU Tactile Tile Self-adhesive

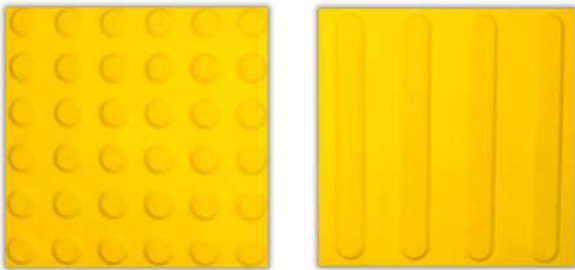

300x300mm (Base 2mm)

PU Tactile Tile Self-adhesive with Moulded Washer

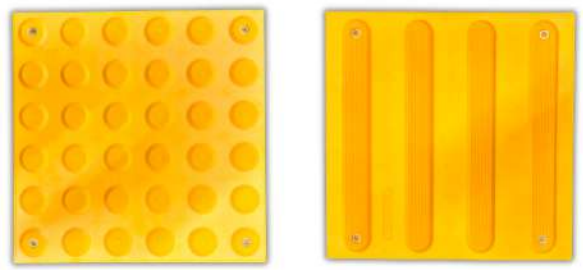

300x300mm (Base 2mm)

ABS Tactile Tile

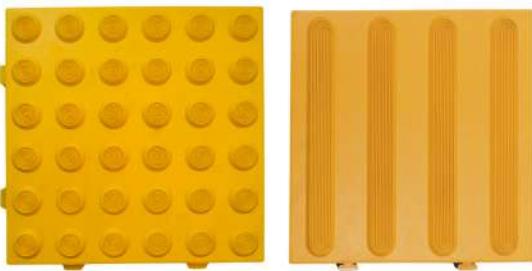

300x300mm (Base 12mm 25mm 40mm)

PU Tactile Strips & Studs



Strip 280x35x5mm - Stud 35x5mm

SS Tactile Tile 304 & 316 Grade



300x300mm (Base 1.8mm)

SS Tactile Strips & Studs 304 & 316 Grade

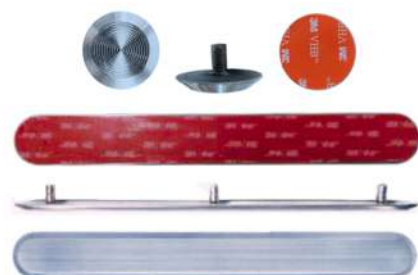

Strip 280x35x4.5mm - Stud 35x4.5mm

**Fully Compliance as per
International Standards**

*Assistive products for blind
and vision-impaired persons
– Tactile walking surface
indicators.*

ISO 23599

- SELF-ADHESIVE
- INSTALLATION IS VERY QUICK
- NO COLOR FADING
- FEEL SOFT
- THE CRACK WILL NOT RISE
- VERY HIGH FRICTION
- HIGH LUMINANCE CONTRAST



QUICK INSTALLTION

NEVER CRACK - NEVER FADE - FEEL SOFT



High Quality Premium Braille Sign Collections

Don't miss this opportunity to upgrade your seating and create a more comfortable and stylish space.



SS Braille Sign
SS 304 Grade



Acrylic Braille Sign
Acrylic Matt Finish



SS Braille Railing Sign
SS 304 Grade



Acrylic Tactile Map
Acrylic Matt Finish



Audio Braille Sign
Acrylic Matt Finish



Wooden Braille Sign
Laminted MDF Wooden Finish

ADA signs are important for a very simple reason: they are required by law. In fact, "ADA" stands for Americans with Disabilities Act, a law enacted in 1990 to prohibit discrimination against people with disabilities in all areas of public life, from transportation to jobs and education and everything in between.



"GRAB SAFETY, LIVE FREELY."
SS 304 GRADE
STAINLESS
STEEL

GRAB BAR

GB-002



GB-001



GB-003



GB-004



GB-005



Signxpress India offers a premium **Accessible Grab Bar** Collection designed for safety and support in restrooms and accessible areas. Made from high-quality stainless steel, these grab bars ensure durability, strength, and ease of use for elderly and differently-abled individuals.



Signxpress India's Accessible Grab Bar is made from high-grade SS304 stainless steel, ensuring strength, durability, and corrosion resistance. Designed for safety and accessibility, it features a smooth, anti-slip finish, supports heavy weight, and is ideal for restrooms, ramps, and accessible spaces. Available in multiple sizes and installation types.

SWING DISABLED GRAB BAR

URINAL SAFETY STEEL GRAB BAR

STRAIGHT DISABLED GRAB BAR

L SHAPED DISABLED GRAB BAR

U SHAPED DISABLED GRAB BAR
(set of 2)



**SIGNXPRESS
INDIA**
SIGN FOR LIFE

OUR RESPECTED CLIENTS

- **POLLAND, UNITED KINGDOM**
- **KUWAIT, SAUDI ARABIA**
- **ROMANIA, UNITED KINGDOM**
- **KATHMANDU, NEPAL**
- **TIMPHU, BHUTAN**
- **NAMO BHARAT RAIL - RRTC**
- **IIT - INDIAN INSTITUTE OF TECHNOLOGY**
- **IIT - KHARAGPUR**
- **DSIIDC GOVT. OF INDIA OFFICES**
- **PWD GUEST HOUSE - REWARI, HARYANA**
- **PWD SCHOOLS - NEW DELHI, INDIA**
- **PWD HOSPITALS - NEW DELHI, INDIA**
- **CPWD RESIDENTIAL COLONY**
- **COMMISSIONER OFFICE - GOA**
- **POST OFFICE - TAMILNADU**
- **ESIC HOSPITAL - BIHAR**
- **GOVT. HOSPITALS - DELHI**
- **BUS STOPS - GUJARAT**
- **NDMC TOILET - NEW DELHI**
- **CPWD - VIGYAN BHAWAN**
- **BLIND SCHOOL - DELHI**
- **SBI BANK - ARUNACHAL PRADESH**
- **CIRCUIT HOUSE - ARUNACHAL PRADESH**
- **GURU TEG BAHADUR UNIVERSITY**
- **NATIONAL HOMEOPATHY**
- **AND MANY MORE.....**



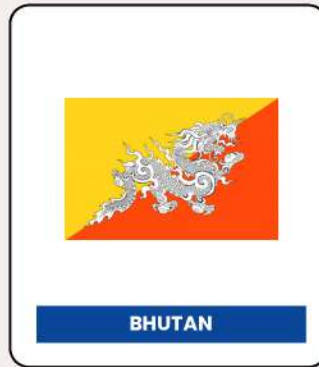
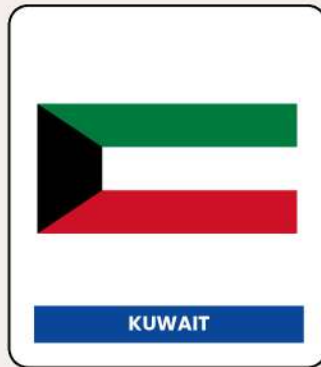
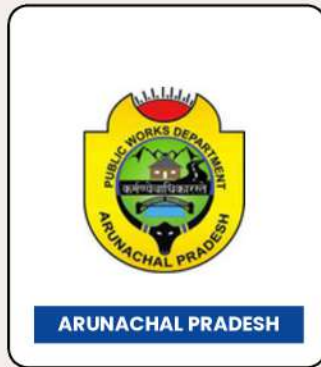



सत्यमेव जयते

भारत सरकार Government of India
राष्ट्रीय परीक्षण शाला (उ.क्षे.)
National Test House (NR)
राष्ट्रीय परीक्षण शाला (उ.क्षे.), कमला नेहरू नगर, गाज़ियाबाद, उत्तर प्रदेश – 201002
Kamla Nehru Nagar, Ghaziabad, Uttar Pradesh - 201002



PART A. PARTICULARS OF SAMPLE SUBMITTED

COMPLETE TEST REPORT

भाग 'अ' जमा किये गये नमूने का विवरण

परीक्षण प्रमाणपत्र सं/Test Certificate No: NTH(NR)/RPPT/22/1688_1
SRF Number: NTH(NR)/RPPT/22/1688
जारी होने की तिथि/Date of issue: 30 Dec, 2022
कोड सं/QR Code/Barcode: NTH220013819

a) जिसे जारी करना है/Issued To	:	SIGNXPRESS INDIA
b) पता/Address	:	C-30, MILAP NAGAR, UTTAM NAGAR EAST, OPP. BANK OF BARODA, DELHI, West, Delhi, India - 110059
c) ग्राहक का संदर्भ सं एवं दिनांक/Customer's Ref. No.	:	No. PUT/ GZB-Testing/101-2022
d) नमूना मुहरबंद स्थिति/Sample Sealed Status	:	Not Sealed
e) परीक्षण सामग्री का विवरण/Description of Test item	:	Make Customized Designs, Patterns, and Colours applicable.
f) नमूना का विशिष्टता (यदि हो)/Product Specification(if any)	:	NTH/NR/RPPT/PU-Tile (2022) - Polyurethane Tactile Tile
g) नमूना प्राप्ति की तिथि /Date of Receipt of the Test item	:	16 Dec, 2022
h) कार्य सम्पादन की तिथि/Date(s)of Performance of Tests	:	From: 28 Dec, 2022 To: 30 Dec, 2022
i) Quantity	:	2.0 no
j) Any other Information / Expiry Date, If any	:	
k) Section Code	:	22RPDF00N
l) Section Report No.	:	22RPDF00N_1
m) Report Type	:	New
n) Reference Report No.	:	
o) Remarks	:	Test report forward as received.

Suresh Parwal
OIC SAMPLE CELL
(Authorized Signatory)
Authorized on: 30 Dec, 2022 12:54 PM

This is a Computer Generated Report.

**TESTED BY NATIONAL
TEST HOUSE**





उपभोक्ता मामले, खाद्य और सार्वजनिक वितरण मंत्रालय
MINISTRY OF CONSUMER AFFAIRS FOOD AND PUBLIC DISTRIBUTION

उपभोक्ता मामले विभाग
DEPARTMENT OF CONSUMER AFFAIRS

भारत सरकार
GOVERNMENT OF INDIA

सत्यमेव जयते

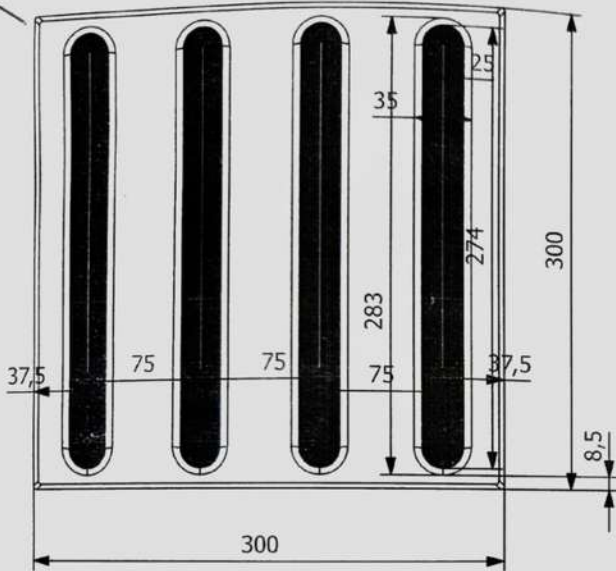

Section Code : 22RPDF00N

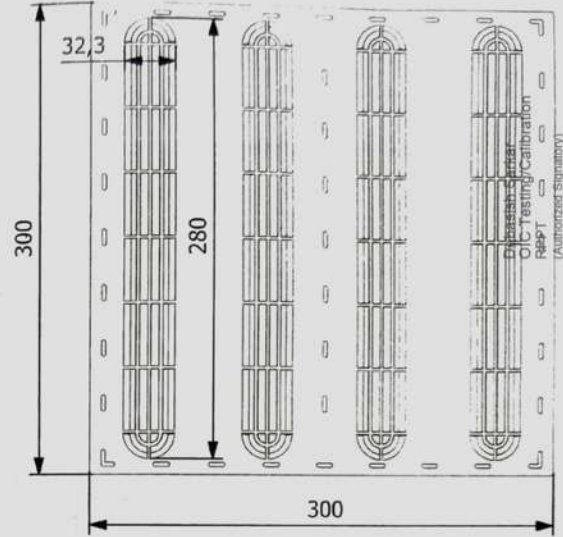
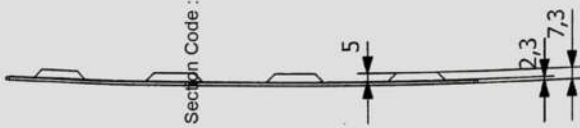

All Demension Are In MM

Ayan Kumar
 29/12/2012
 देबाशिस सरकार / DEBASISH SARKAR
 कृषि विज्ञान केंद्र (रा.वि.क.) / Scientist C (RPPT)
 राष्ट्रीय खाद्य सुरक्षा (रा.वि.) / National Food House (RFH)
 कृषि विज्ञान संस्थान, कानपुर / Kashi Sahas Nigam, Ghazabad
 Lab Sc. Testing/Calibration
 RPPT
 (Authorized Signatory)

Page 4 of 6

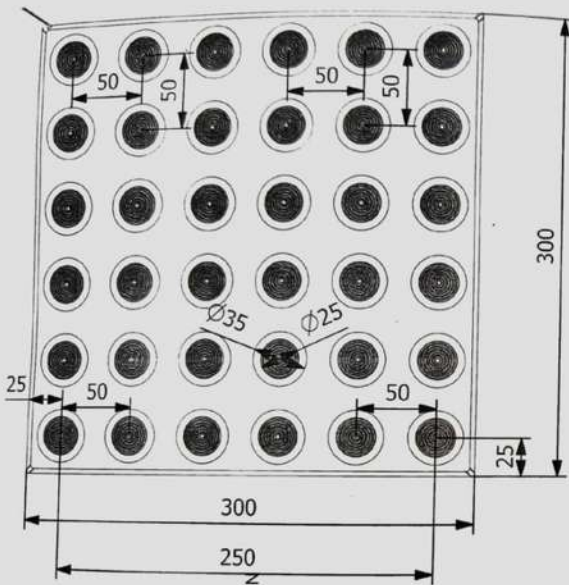

Section Code : 22RP1A5FN

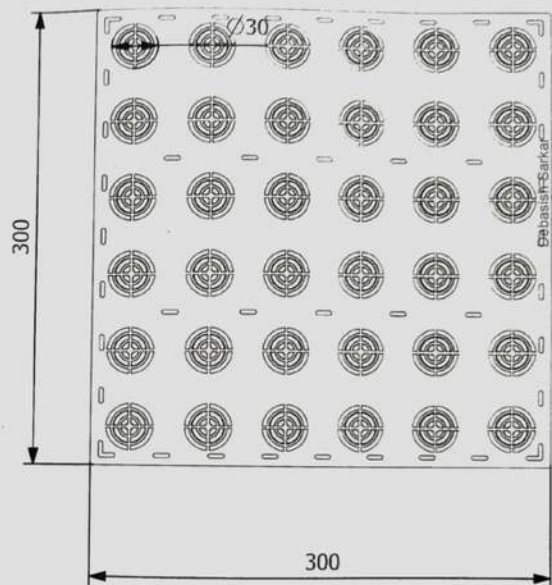

All Demension Are In MM

Ayan Kumar
 29/12/2012
 देबाशिस सरकार / DEBASISH SARKAR
 कृषि विज्ञान केंद्र (रा.वि.क.) / Scientist C (RPPT)
 राष्ट्रीय खाद्य सुरक्षा (रा.वि.) / National Food House (RFH)
 कृषि विज्ञान संस्थान, कानपुर / Kashi Sahas Nigam, Ghazabad
 Lab Sc. Testing/Calibration
 RPPT
 (Authorized Signatory)

Page 5 of 6

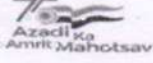

दिल्ली सरकार
प्रमुख अभियंता, लो0नि0वि0,
12वां तल, बहु-मंजिला भवन, इंद्रप्रस्थ संपदा, नई दिल्ली:110002
☎ 23490093, फ़ैक्स23766924
Toll Free Complaint No. 1800 11 0093
वेबसाइट: <http://pwd.delhigovt.nic.in>
ई-मेल: dirw-pwd@delhi.gov.in



No.E-in-C/PWD/Works/2023/NMET./ 3137

Dated: .05.2023

25

OFFICE MEMORANDUM

Subject: Approval of Preferred make/brand name of M/s SIGNXPRESS INDIA.

Approval of Competent Authority is hereby conveyed to incorporate the make/brand mentioned below in the list of approved make of future NIT's of PWD works.

S. No.	Description of items.	Brand of Product.
1.	PU Tactile Tiles (Warning & Direction)	M/s SIGNXPRESS INDIA.
2.	PU Tactile Strips with Stem (Direction).	
3.	PU Tactile Stud with Stem (Warning).	
4.	Acrylic Braille Signage.	
5.	Stainless Steel Braille Signage.	
6.	Stainless Steel Strip.	
7.	Stainless Steel Stud.	

1.) This approval is for a period of **two years** from the date of issue of this office memorandum and will automatically lapse at the end of this period.

2.) CE's, SE's, EE's & AE's are required to incorporate the above brand along with the already approved other brands in the "**List of Preferred Makes**" in the NIT's to be approved by them.

3.) While specifying different brands of a product the CVC guidelines regarding quality and price of equivalent brands must be followed.

4.) This approval does not absolve the Executive/Supervisory officers concerned of their responsibility of exercising necessary checks like quality, rates & performance of the product while processing/using the same. Shortcoming/deficiencies, if observed while in use at site shall be brought to the notice of this office.

5.) This approval does not make the firm eligible for claiming the right to get the work done or items procured through them only. Work/ Procurement is subject to



firm's competitive offers against other competing manufactures/Brands/Suppliers as mentioned in NIT.

6.) The performance of the firms shall be watched by field units and report shall be submitted for periodical review.

This issues with the approval of Engineer-in-Chief, PWD GNCTD.

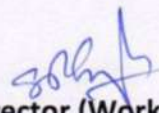

Dy. Director (Works)
PWD, GNCTD.

Copy To:

1. Pr. C.E. (Project), 9th floor MSO Building, IP Estate, New Delhi.
2. Pr. C.E. (M&F), 12th floor MSO Building, IP Estate, New Delhi.
3. CE (East), 3rd floor MSO Building, IP Estate, New Delhi.
4. CE (North), 5th floor MSO Building, IP Estate, New Delhi.
5. CE (South), 7th floor MSO Building, IP Estate, New Delhi.
6. CE (Flyover), 4th floor MSO Building, IP Estate, New Delhi.
7. CE (Health), 2nd floor MSO Building, IP Estate, New Delhi.
8. CE (Projects), 1st floor MSO Building, IP Estate, New Delhi.
9. CE (O.P.), 13th floor MSO Building, IP Estate, New Delhi.
10. Mr. Honey Chugh, CEO & MD (Technical) C-30, Milap Nagar, Uttam Nagar East, New Delhi-110059. India (M) 9810032137, (E) info@signxpressindia.com.

HONEY CHUGH
CEO, MD TECHNICAL

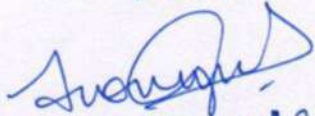
9810032137

25/5/2023

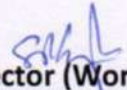
Dy. Director (Works)
PWD, GNCTD.



No. DSIIDC/EE/2024-2025/736

Date :- 04.01.2024

Subject: Approval of Preferred make/brand name of M/s SIGNXPRESS INDIA

Approval of competent Authority is hereby conveyed to incorporate the make/brand mentioned below in the list of approved make of future NIT's of DSIIDC works.

S. No.	Description of items.	Brand of Product.
1	PU Tactile Tiles (Warning & Direction)	M/s SIGNXPRESS INDIA
2	PU Tactile Strip with Stem/Self-adhesive (Direction)	M/s SIGNXPRESS INDIA
3	PU Tactile Stud with Stem/Self-adhesive (Warning)	M/s SIGNXPRESS INDIA
4	Acrylic Braille Signage	M/s SIGNXPRESS INDIA
5	Stainless Steel Braille Signage	M/s SIGNXPRESS INDIA
6	Stainless Steel Tactile Strip	M/s SIGNXPRESS INDIA
7	Stainless Steel Tactile Stud	M/s SIGNXPRESS INDIA

1. This approval is for a period of Five Years from the date of issue of this letter.
2. All Engineers are required to incorporate the above brand along with the already approved other brands in the "List of Preferred Makes" in the NIT's to be approved by them.

The issue with the approval of Engineer-in-chief, DSIIDC - Delhi State Industrial and infrastructure Development Corporation

Executive Engineer(Maint.)



समृद्धि कल्पना
THE ASPIRE - ONE DREAM - ONE FUTURE

भारत सरकार
GOVERNMENT OF INDIA
केन्द्रीय लोक निर्माण विभाग
CENTRAL PUBLIC WORKS DEPARTMENT



कार्यालय-कार्यपालक अभियन्ता
राममनोहो मंडल, को लो नि वि
नई दिल्ली-110001,
दूरभाष :23365663,23345291/ फैक्स:23365663
ई-मेल : deleecrmlh.cpwd@nic.in

Office of Executive Engineer
RML Division, C.P.W.D.
New Delhi-110001
PH No. 23365663, 23345291/ Fax : 23365663
E-Mail- deleecrmlh.cpwd@nic.in

पत्र सं०:-26(1)/योजना शाखा/राममनोहोमं/2024-25/1180

दिनांक: 29/08/2024

PERFORMANCE CERTIFICATE

To,

Signxpress India
RZ-8, Uttam Nagar East
New Delhi-110059

Sub: Work Completion and Appreciation for Signxpress India's Excellent PU Tactile, & Braille Signage services at Ram Manohar Lohia, OPD (CPWD)

I am writing to express a heartfelt appreciation for the exceptional products and services provided by Signxpress India work at Ram Manohar Lohia, OPD (CPWD).

Signxpress India, as the manufacture responsible for supplying PU Tactile Tiles and Braille Signage, has exceeded our expectations in every aspect of this project. Their commitment to quality, attention to detail, and dedication to meeting project deadlines have been exemplary. The PU Tactile Tiles and Braille Signage supplied by Signxpress India have not only met but also surpassed the highest standards of quality and durability. These products have significantly enhanced the accessibility and safety of the public infrastructure within our jurisdiction, aligning perfectly with our mission of creating inclusive environments.

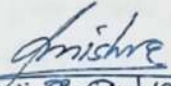
Executive Engineer (C)
RML Division
CPWD, New Delhi



CPWD



PWD Delhi

PUBLIC WORKS DEPARTMENT

Ref. No. 2(01)/JE/SE(B)M/SLC/2023-24/

Dated:14.02.2024

PERFORMANCE CERTIFICATE

To,

Signxpress India
RZ-8, Uttam Nagar East
New Delhi-110059

Sub: Work Completion and Appreciation for Signxpress India's Excellent Products

I am writing to express my heartfelt appreciation for the exceptional products and services provided by Signxpress India work at GGSSS No. 3, Badarpur.

Signxpress India, as the manufacture responsible for supplying PU Tactile Tiles and Braille Signage, has exceeded our expectations in every aspect of this project. Their commitment to quality, attention to detail, and dedication to meeting project deadlines have been exemplary. The PU Tactile Tiles and Braille Signage supplied by Signxpress India have not only met but also surpassed the highest standards of quality and durability. These products have significantly enhanced the accessibility and safety of the public infrastructure within our jurisdiction, aligning perfectly with our mission of creating inclusive environments.

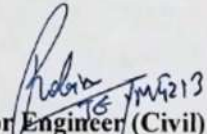
Junior Engineer (Civil)
Sub-Division-III, SE(B)M PWD
Sunlight Colony, New Delhi.

Junior Engineer (C)
Enquiry Office, PWD
Sunlight Colony, New Delhi





༄ | ཇི་དང་གེ་བཟོ་རིག་ལས་ལས་གཉེན་ལཱ་ཚོང་འཕྲིན།
T & K CONSTRUCTION PRIVATE LIMITED
Experienced in Road and Building Construction with Traditional Architecture.

Appreciation Letter

Sub: Work Completion and Appreciation for Signxpress India's Excellent Products and Services at Construction of Bhutan Trust Fund For Environmental Conservation

Dear Mr. Honey Chugh,

I am writing to express my heartfelt appreciation for the exceptional products and services provided by Signxpress India during our recent project for BTFEC at Thimphu, Bhutan with the T&K Construction pvt. Ltd. under the Finance department.

Signxpress India, as the manufacture responsible for supplying PU Tactile Tiles and Braille Signage, has exceeded our expectations in every aspect of this project. Their commitment to quality, attention to detail, and dedication to meeting project deadlines have been exemplary. The PU Tactile Tiles and Braille Signage supplied by Signxpress India have not only met but also surpassed the highest standards of quality and durability. These products have significantly enhanced the accessibility and safety of the public infrastructure within our jurisdiction, aligning perfectly with our mission of creating inclusive environments.

Key points of appreciation include:

Product Excellence: Signxpress India's PU Tactile Tiles and Braille Signage have demonstrated exceptional quality, complying with all relevant standards and regulations.

Timely Completion: The project was executed with remarkable efficiency, meeting all project milestones and deadlines.

Professionalism: The Signxpress India team exhibited professionalism, responsiveness, and a strong commitment to customer satisfaction throughout the project.

Innovation: Their products reflect cutting-edge innovation in the field of accessibility, making a significant impact on public infrastructure.

We believe that Signxpress India's contributions have not only improved the physical landscape of our region but have also enriched the lives of our citizens by providing safer and more accessible public spaces.

On behalf of the T&K Construction private limited under the finance department, I would like to extend our sincere gratitude to Signxpress India for their outstanding work. We look forward to the possibility of collaborating on future projects and further enhancing the accessibility and inclusivity of our public infrastructure.

Please convey our appreciation and recognition to the entire Signxpress India team for their dedication and commitment to excellence

Thank you once again for the outstanding products and services provided by Signxpress India.

Sincerely,

Jigme Ugyen Gyamtsho
Director-Finance

21/11/2023

**OFFICE OF THE EXECUTIVE ENGINEER (SD)
NEW DELHI MUNICIPAL COUNCIL
2ND FLOOR ROOM NO 2001-C
PALIKA KENDRA, NEW DELHI**

No. D/ 495 /EE(SD)/2023

Date 05/12/23

M/s Signxpress India.
RZ-8, Mahindra park Uttam Nagar east
New Delhi-110059

Sub: - The request for Free sample disabled friendly Signage and Self-adhesive PU Tactile Tiles in NDMC Public Toilets at Hanuman Mandir New Delhi, Location Code CTU 03-005.

This is with reference to your letter dated 04.10.2023 regarding high-quality accessibility signage solutions by providing Braille signage and Self-adhesive PU Tactile Tiles. You are requested to install as samples of Braille signage and PU tiles signage at CTU 03-005 NDMC Toilets at Hanuman Mandir, New Delhi Location on free of cost for actual evaluation of the performance at the site. It shall be ensured that there shall not be damage to original finishing.

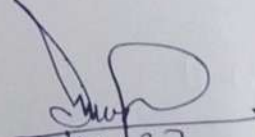
05/12/23
(Er. C. L. Meena)
Executive Engineer (SD)



नई दिल्ली नगरपालिका परिषद्

NORTHERN RAILWAY



No. 128-W/260/QTN/08/2023-24/W-II
Dated : 06.02.2024

DRM's Office
New Delhi

M/s Sign Xpress India,
RZ-8, Mahendra park,
uttam nagar, East, Delhi-110059

Sub :- Installation/Providing PU TACTILE & BRAILLE SIGNAGE at DSA Station in the section of SSE/W/M/GZB, under ADEN /GZB N.RLY"

D/Sir,

In continuation of your quotation of dated 17.01.2024, in connection with the noted work at the rates shown below have been accepted by the Competent Authority for and on behalf of President of India subject to the terms and conditions as embodied in the tender conditions of the contract and subject to the Northern Railway Engineering Department General Conditions of the Contract Regulations and Instructions for the Tenderer and Standard form of contract, 2018 edition (corrected up to date) and Standard specifications for the material and works 2010 edition (Corrected up to date) and standard schedule of rates 2010 edition (Corrected up to date) and special condition as attached along with quotation.

S.N	Description of Item	Qty
Item No	Description of Items	
1	Providing & fixing PU Tactile tile 01 (DIRECTIONAL) Dimension: 300x300x7.3 mm Fixing: Self-adhesive tape including all taxes, charges, all L&M, T&P as a complete job. Nothing extra will be paid whatsoever the case may be.	10.50
2	Providing & fixing PU Tactile tile TILE 02 (WARNING) Dimension: 300x300x7.3 mm Fixing: Self-adhesive Tape including all taxes, charges, all L&M, T&P as a complete job. Nothing extra will be paid whatsoever the case may be.	90
3	Providing & fixing braille signage acrylic material: 3mm acrylic sheet matt of standard sizes: 200X200, 200X150, 300X150, 450X450 (MM) including all taxes, charges, all L&M, T& as a complete job. Nothing extra will be paid whatsoever the case may be.	0.7
4	Providing & fixing braille signage stainless steel material: 0.5 stainless steel 304 grade of standard sizes: 200X200, 200X150, 300X150, 450X450, 200X50 (MM) including all taxes, charges, all L&M, T&P as a complete job. Nothing extra will be paid whatsoever the case may be.	0.2
5	Providing & fixing antiskid tape for staircase Yellow Reflective Tape: 25mm, Black Anti-skid Tape: 25+25mm, Yellow Retro Reflective Tape: 50mm including all taxes, charges, all L&M, T&P as a complete job. Nothing extra will be paid whatsoever the	50
6	Providing & ixing talking braille signage acrylic material: 3mm acrylic sheet matt of standard sizes: 200X200, 200X150, 300X150, 450X450 MM including all taxes, charges, all L&M, T&P as a complete job. Nothing extra will be paid whatsoever the case may be.	0.25

*Tech. checked
Signature of*

- Offered rates shall be considered to be included of all taxes, octroi, cost of fuel, labour, T&P machinery, vehicles, lift ascent, descent GST etc. No claim on any account will be made except payment of accepted rates only.
- Please report to ADEN/GZB for taking further instruction for starting the work immediately, completion of this work will be 10 Days from the acceptance of the quotation. The cost of the work is Rs. 496090.75

[Signature]
27/2/24
Sr. Divisional Engineer-II
N. Ry., N. Ry., New Delhi
State Entry Road, NDLS

Copy to:- ADEN/GZB for information and necessary action please.

Works Contract

 <small>Enduring Value</small>	REGISTERED OFFICE: ITC LIMITED , VIRGINIA HOUSE, 37 J.L. NEHRU ROAD KOLKATA-700071 TELEPHONE: 91-33-22889371/9900 , FAX : 91-33-22881256 Visit us at www.iteportal.com * Corporate Identity Number: L16005WB1910PLC001985								
Vendor code: 217785 Vendor : SIGNXPRESS INDIA UTTAM NAGAR , NEW DELHI 110059 India GSTIN :07ABKPH4628N2Z8 State Code: 07, State Name: Delhi	Purchase order number : 4300002793 Currency : INR Date: 15.12.2023 Page 1 of 5 Contact No: 080-22982201								
Bill to and Ship to Address: ITC Limited - FMS No. 18, Banaswadi Main Road, Maruthiseva Nagar, Bangalore 560005, India GSTIN :29AAAC15950L1Z6 State Code:29, State Name:Karnataka									
SI	Delivery Date	HSN/SAC Code	Item Desc						
Quantity	UOM	Rate / UOM	Taxable Rate	SGST / UGST	CGST	IGST	CESS	Total Price	
10	14.01.2024	995419	UA - Supply & Fixing of PU Tactile Guida						
Universal Accessibility - Supply & Fixing of PU Tactile Guidance System at Green Centre: M/s. SIGNXPRESS INDIA- As per Annexure. Terms & Conditions to be included (If any): I.General Terms : 1.Invoice to be raised on ITC LIMITED, CPO, No. 18, Maruthi Sevanagar, Banaswadi Main Road, Bengaluru - 560005. 2.GST & PAN to be mentioned on the Invoices. II.Payment Terms : 1.75% on supply of materials at site will be paid within 10 days from the date of submission of the undisputed invoice. 2.Balance on completion of installation within 15 days from the date of submission of the undisputed invoice. III.Time Line : >Entire activity will be completed within 3 to 4 weeks from the date of issue of PO/LOI. IV.Scope of work : 1.Submission of samples for approval by ITC & ITC engaged consultant.									
Payment will be made after inspection, verification of quantities supplied, actual measurements and satisfactory completion of all work duly certified by our representatives									
For ITC Limited Central Projects Organisation Buyer's Signature:			We accept your Order No 4300002793 dated 15.12.2023, on the terms and conditions stated herein, stated overleaf and in the enclosure attached here to / contracts entered into (if any) and undertake delivery/ executions as stipulated. Please return One copy Signed in original to the Consignee's address as mentioned above.						



Vendor Signature



Dr. P. V. Madhusudhan Rao
Professor of Mechanical Engineering & Design
Dean, Alumni Relations

Office of Alumni Relations
INDIAN INSTITUTE OF TECHNOLOGY DELHI
Hauz Khas, New Delhi-110 016, India
Tel.: 011-26548551
Email: alumnidean@admin.iitd.ac.in
pvmrao@design.iitd.ac.in

Purchase Order

SIGNXPRESS INDIA

C-30, Milap Nagar, Uttam Nagar East,
New Delhi 110059 India

Date: 23/01/2023

Sub-: Purchase of PU Tactile Strip-SH-11, PU Tactile STUD-SH-12

With reference to your Quotation No. : SI/2022-2023/0405 Dated: 14/01/2023 we would like to place an order for PU Tactile Strip-SH-11, PU Tactile STUD-SH-12

SL.No	PIN & Description	Qty.	Unit Price	Total Amount
01	1 PU TACTILE STRIP-SH-11 (4pcs)			
02	2 PU TACTILE STUD-SH-12 (36pcs)			
	Freight			
	GST 18%			
	Total			

Term & Conditions

1. Packing, forwarding and flight charges etc. are included in the price
2. Rates are inclusive of all taxes, duties, etc.
3. Free of cost installation and on campus training will be provided by the agency.
4. TDS as applicable on date will be deducted at source.
5. No escalation in respect of custom duty, flight, etc. will be allowed.
6. Payment will be made after supply, satisfactory, installation and training of the item as certified by the concerned officer.
7. Warranty shall be provided as per the agreement/terms and condition warranty card should be submitted along with the bill.
8. Any documents, files shared by IIT for the above job should not be shared with any other person/entity without the proper approval of undersigned.
9. Delivery should not be later than 2 Weeks from the date of issue of purchase order.
10. Payment will be made as per IIT Norms.

Any dispute arising out of this supply order will be under jurisdiction of Delhi court.

(P.V.M Rao)



Government of Meghalaya
OFFICE OF THE MEDICAL SUPERINTENDENT,
CIVIL HOSPITAL, KHLIEHRIAT, EAST JAINTIA HILLS DISTRICT

No: 99/IPA/SO/2024-25/06

Dated: Khliehriat, the: 10/06/2024

To,

SIGNPRESS INDIA,
Uttam Nagar East, Delhi
110059 India

Subject: Supply Order

Ref No: Estimate No: SI/2024-2025/0091, dated: 02/05/2024.

Sir/Madam,

With reference to the above mentioned subject we are pleased to inform you that your quotation for the following has been accepted and you are hereby requested to kindly supply according to your quoted rate to the above mentioned Address.

SL No	Item Name	Quantity	Rate
1	Braille Signage		

Yours Faithfully

IPA Incharge,
Medical & Health Officer,
Khliehriat Civil Hospital,
East Jaintia Hills, Meghalaya.
Medical & Health Officer
Khliehriat Civil Hospital
East Jaintia Hills District



། ཨིན་གེ་ཤོ་རྩེ་གསལ་ལས་གཉེན་ལཱ་སྐོར་སྐོར་ལྷན་ཁོངས་།
T & K CONSTRUCTION PRIVATE LIMITED
Experienced in Road and Building Construction with Traditional Architecture.

PO No: T&K-SXI/BTFEC/PO2023/406

Date : 13.10.2023

TO	SHIP TO
SIGNXPRESS INDIA C-30, Milap Nagar, Uttam Nagar East, New Delhi 110059 GSTIN 07ABKPH4628N2Z8, PAN-ABKPH4628N connect.signxpressindia@gmail.com	T&K Construction Pvt. Ltd. For Bhutan Trust Fund for Environmental Conservation Office Building Thimphu
Contact: Muskan (Sales Person) Mobile No. 01145527272	Contact: Jigme U Gyamtsho Mobile No.

Subject : Purchase Order.

Sl. No.	PARTICULARS	HSN/SAC	QTY	RATE
1	PU TACTILE TILE DIRECTONAL-TESA-01 Dimension: 300x300x7.3 mm Strip Pattern: Strip with anti Slip Concentric Pattern Tape : Self-adhesive Tesa Tape Pattern : Directional	39261091		
2	PU TACTILE TILE WARNING-TESA-02 Dimension: 300x300x7.3 mm Strip Pattern: Strip with anti Slip Concentric Pattern Tape : Self-adhesive Tesa Tape Pattern : Warning	39261091		
TOTAL AMOUNT			INR.	

For & on behalf of
T&K Construction Pvt. Ltd.



SIGNXPRESS INDIA

MANUFACTURING

In-house all inclusive



Tool Room



Molds & Moldings



VMC Machines



Pack & Dispatch



FAST PROCESS



SUPREME QUALITY



ACCURACY

Signxpress India produces 10,000 PU Tactile tiles daily, ensuring efficient manufacturing to meet accessibility needs and enhance safety for visually impaired individuals nationwide.



दिव्यांगजन लोगों का समर्थन करने के लिए एकजुट होने से अर्थपूर्ण परिवर्तन हो सकता है। साथ मिलकर, हम बाधाओं को तोड़ सकते हैं, समावेश को बढ़ावा दे सकते हैं और सभी के लिए समान अवसर सुनिश्चित कर सकते हैं।

Coming together to support people with disabilities can lead to meaningful change. Together, we can break down barriers, promote inclusion and ensure equal opportunities for all.



 (91) 9810032137 (91) 8882221880

 www.signxpressindia.com

 info@signxpressindia.com

 RZ-8, Uttam Nagar East, New Delhi-110059. (INDIA)

Thank you